

1

2

3

4

5

6

A

A

B

B

C

C

D

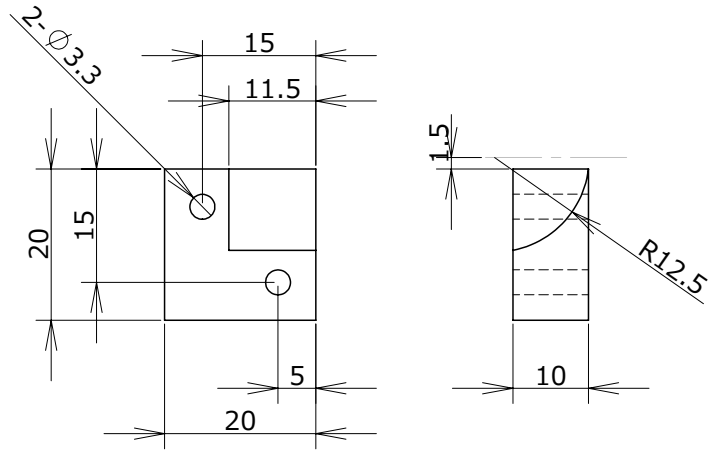

APPROVED
YYYY.MM/DD -
CHECKED
YYYY.MM/DD -
DESIGNED

SCALE	THIRD ANGLE	2017.6/12
1:1		sekihara shu

REV.2		MATERIAL	ABS樹脂
REV.1		PART NAME	バッテリーホルダ-21
FINISH	-	DRAWING CODE	-
TREATMENT	-		